

LED Dimmer

Model No.: V1-C

3-button / RF dimming / Four PWM frequency / Multiple protection

Features

- 1 channel constant voltage LED RF dimmer with 3-button.
- Switch and dimming by 3 buttons.
- Match with RF 2.4G single zone or multiple zone dimming remote control optional.
- One RF controller accept up to 10 remote control.
- 4096 levels 0-100% dimming smoothly without any flash.
- PWM frequency 500Hz, 2KHz, 8KHz or 16KHz selectable.
- Over-heat / Over-load / Short circuit protection, recover automatically.



CE RoHS RED

Technical Parameters

Input and Output		Dimming data		Safety and EMC	
Input voltage	12-24VDC	Input signal	3-button + RF 2.4GHz	EMC standard (EMC)	ETSI EN 301 489-1 V2.2.3 ETSI EN 301 489-17 V3.2.4
Input current	20.5A	Control distance	30m(Barrier-free space)	Safety standard	EN 62368-1:2020+A11:2020
Output voltage	12-24VDC	Dimming gray scale	4096 (2 ¹²) levels	Radio Equipment(RED)	ETSI EN 300 328 V2.2.2
Output current	20A@500Hz/2KHz 15A@8KHz 12A@16KHz	Dimming range	0-100%	Certification	CE,EMC,RED
Output power	240-480W@500Hz/2KHz 180-360W@8KHz 144-288W@16KHz	Dimming curve	Logarithmic	Package	
Environment		PWM frequency	500Hz/2KHz/8KHz/16KHz	Size	L100 x W46 x H38mm
Operation temperature	Ta: -30°C ~ +55°C	Warranty and Protection		Gross weight	0.081kg
Case temperature (Max.)	Tc: +85°C	Warranty	5 years		
		Protection	Reverse polarity Over-heat Over-load Short circuit		

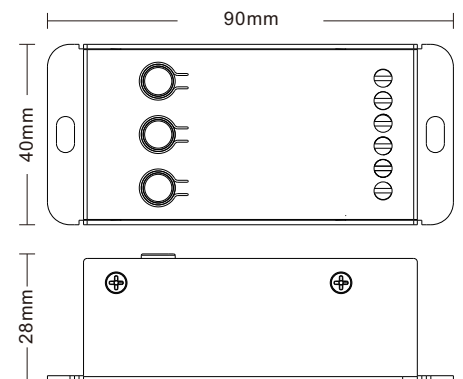
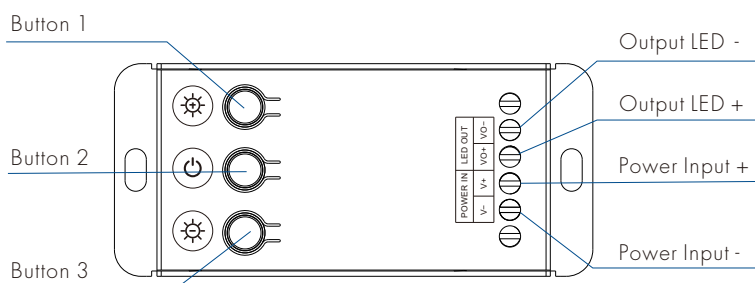

Mechanical Structures and Installations

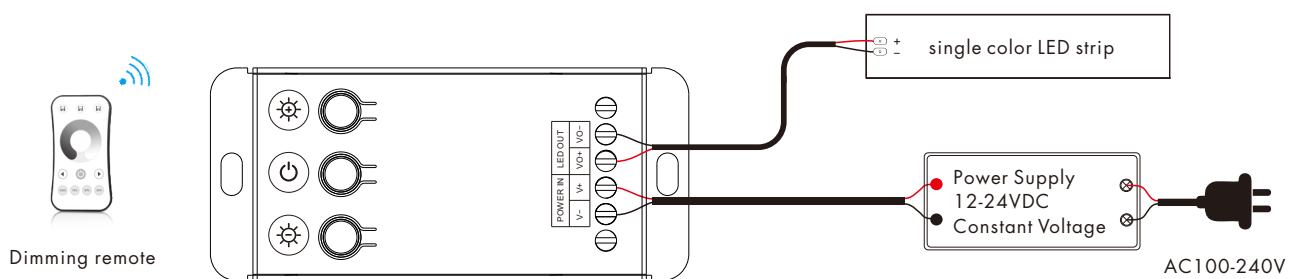

Wiring Diagram



Button function

-  Increase brightness, short press 10 levels, long press 1-6s for continuous 256 levels adjustment.
-  Turn on or off light.
-  Decrease brightness, short press 10 levels, long press 1-6s for continuous 256 levels adjustment.

PWM frequency setting

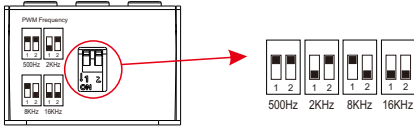

We can select four PWM frequency: 500Hz, 2KHz, 8KHz or 16KHz.
Higher PWM frequency, will cause lower output current, higher power noise,
but more suitable for camera(No flickers for video).

Match Remote Control (two match ways)

End user can choose the suitable match/delete ways. Two options are offered for selection:

Use the controller's button

Match:

Long press button1 and button 3 for 2s,
immediately press on/off key (single zone remote)
or zone key (multiple zone remote) of the remote.

Delete:

Press and hold button1 and button 3 for 5s to delete all match,
The light blinks 5 times means all matched remotes were deleted.

Use Power Restart

Match:

Switch off the power, then switch on power again, repeat again,
immediately short press on/off key (single zone remote)
or zone key (multiple zone remote) 3 times on the remote.
The light blinks 3 times means match is successful.

Delete:

Switch off the power, then switch on power again, repeat again,
immediately short press on/off key (single zone remote)
or zone key (multiple zone remote) 5 times on the remote.
The light blinks 5 times means all matched remotes were deleted.

Dimming Curve

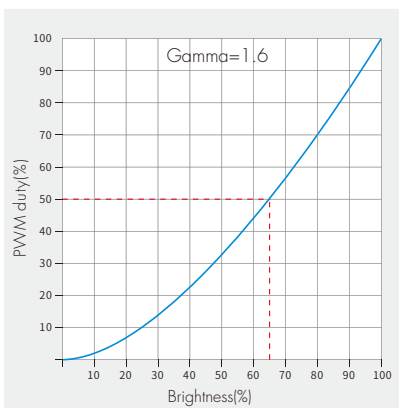

Installation Precautions

1. The products shall not be stacked, the distance should be ≥ 20 cm, so as not to affect lifespan of the products due to poor heat dissipation.
2. The product shall not be installed close to the switching power supply with an interval of ≥ 20 cm to avoid the radiation interference of the switching power supply.
3. The installation height shall be ≥ 1 m from the floor to avoid shortening the remote control distance due to too weak reception signal.
4. The products are not allowed to be close to or covered by metal objects, with an interval of ≥ 20 cm to avoid signal attenuation and shorten the remote control distance.
5. Avoid installation at the corner of the wall or the corner of the beam, with an interval of ≥ 20 cm to avoid signal interference.